

# RECESSED LINIA

## 3G-4RLI

### 3.5" RECESSED

TRIM, TRIMLESS & FLANGELESS

# 3G

LIGHTING

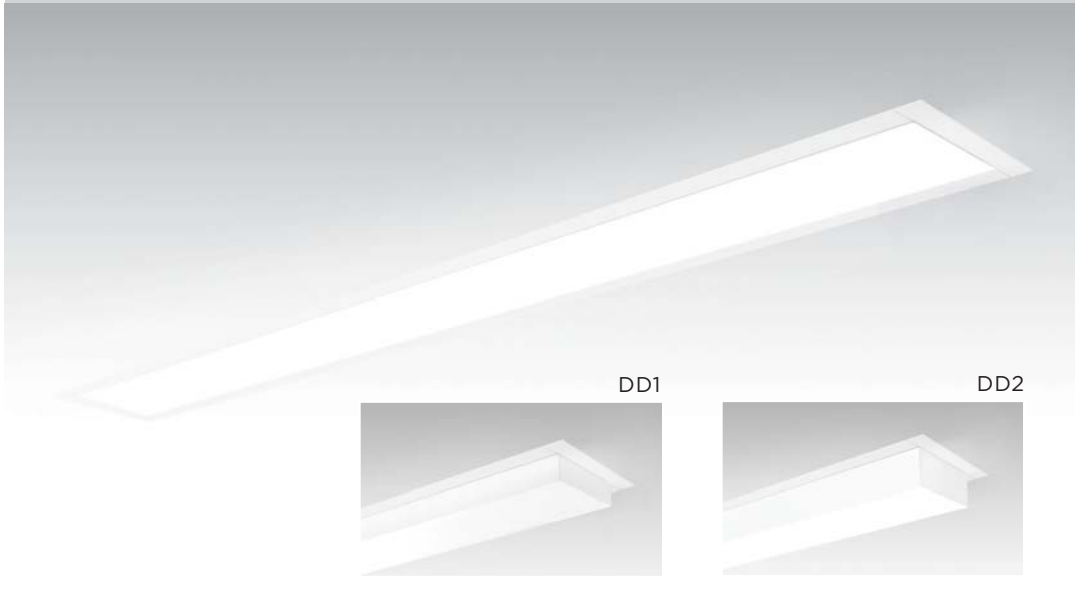

Pendant Linia



Surface Linia



Wall Linia

## FEATURES

### CONSTRUCTION

- Extruded aluminum housing with 3.5" aperture
- Individual units and continuous runs in 1' increments
- Trimless model features mudding flange
- Trim model features a 5/8" trim flange
- 24 gauge LED reflector with high reflectance white powder coated finish
- Extruded acrylic lens with a satin finish available in flush and unique drop lens options

### ELECTRICAL

- Standard 120-277V, 0-10V dimmable driver with 100-1% dimming range
- 85% efficiency and 0.9 power factor
- Lutron driver options available with 100-1% dimming range
- eldoLED Dali driver available with 100-1% dimming range
- Emergency Battery: 90 minutes

### LED SYSTEM

- Available in 27K, 30K, 35K, and 40K
- Average rated life of >50,000 hours
- Color consistency 3 SDCM
- CRI>80 for 27K, 30K, 35K, and 40K

### LUMEN MAINTENANCE

- L70 at 50,000 hours

### MOUNTING

- Suitable for drywall and wood ceilings (see mounting details)

### FINISH

- Polyester powder coated matte white with 95% reflectance

### LABELS

- ETL listed. Suitable for dry or damp locations

### WARRANTY

- 5 Year limited warranty

<b>PROJECT</b>	<b>TYPE</b>	<b>DATE</b>
<b>CATALOG #</b>		

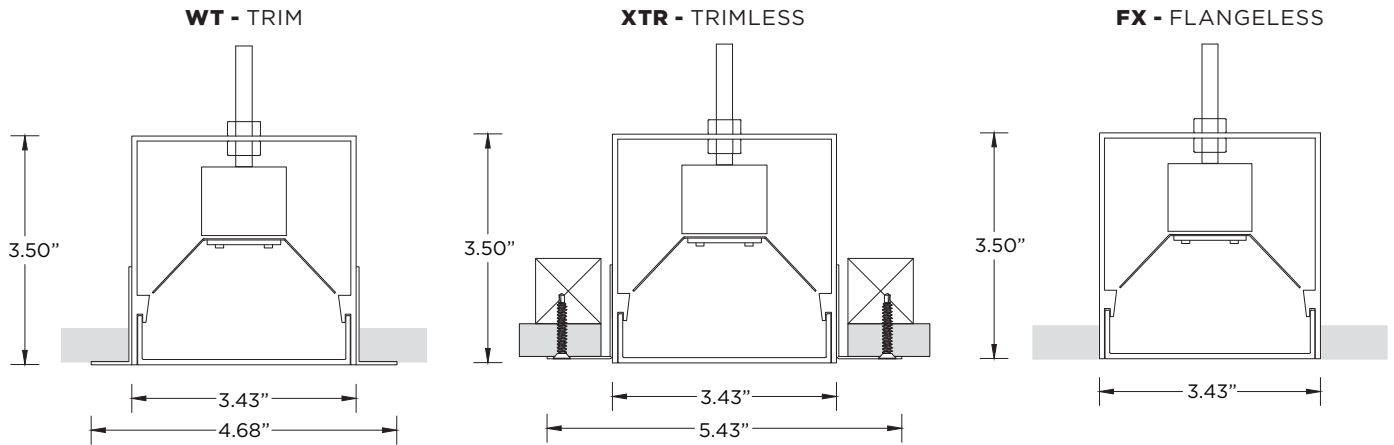

<b>CUTOUT</b>	4.08" (± 0.063")	4.08" (± 0.063")	3.493" (+0" - 0.063")
<b>TRIM &amp; TRIMLESS LENGTH CUTOUT - ADD 0.500"</b>		<b>FLANGELESS LENGTH CUTOUT - ADD 0.125"</b>	

**LENS OPTIONS**

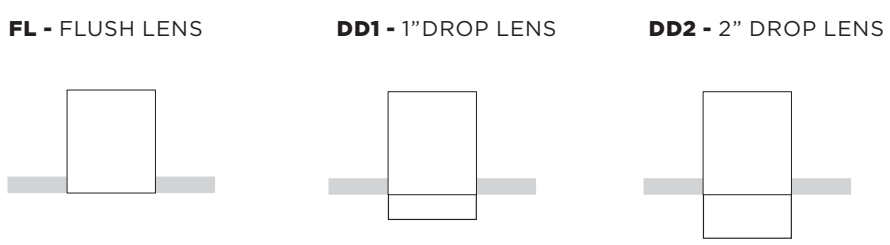

**ORDERING INFORMATION**

CAT. NO	LED SYSTEM	COLOR TEMP	VOLTAGE	DRIVER
<b>3G-4RLI</b>	<b>L1</b> - LOW OUTPUT	<b>27K</b> - 2700K	<b>120</b> - 120V	<b>DIM</b> - 0-10V (STANDARD - 100-1%)
	<b>L2</b> - STANDARD OUTPUT	<b>30K</b> - 3000K	<b>277</b> - 277V	<b>DHL</b> - LUTRON(3-WIRE - 100-1%)
	<b>L4</b> - HIGH OUTPUT	<b>35K</b> - 3500K	<b>347</b> - 347V (0-10V ONLY)	<b>DHL2</b> - LUTRON (ECOSYSTEM - 100-1%)
		<b>40K</b> - 4000K		<b>DALI</b> - DALI (100-1%)
<b>3G-4RLI</b>				

FLANGE TYPE	LENS OPTIONS	OPTIONS	LENGTH (FEET)
<b>XTR</b> - TRIMLESS <b>WT</b> - WHITE TRIM <b>FX</b> - FLANGELESS	<b>FL</b> - FLUSH <b>DD1</b> - 1" DROPLENS <b>DD2</b> - 2" DROPLENS	<b>EM</b> - EMERGENCY BATTERY (4' SECTION) <b>CP</b> - CHICAGO PLENUM	<b>S</b> - ___' (STRAIGHT RUN)* <b>L</b> - ___' X ___' (L-SHAPE) <b>U</b> - ___' X ___' X ___' (U-SHAPE) <b>R</b> - ___' X ___' (RECTANGLE/SQUARE)

\*Individual units available in 3', 4', 5', or 8'. Continuous runs available in 1' increments.

ORDERING EXAMPLE	<b>3G-4RLI-L2-30K-120-DIM-XTR-FL-S-8'</b>
------------------	---

# RECESSED LINIA

**3G-4RLI**  
**3.5" RECESSED**  
 TRIM, TRIMLESS & FLANGELESS



## PERFORMANCE CHART (Based on 3500K, 4' length)

LENS OPTIONS	LED SYSTEM	WATTAGE/FT	LUMENS/FT	EFFICACY (LM/W)	IES FILES
<b>FLUSH</b>	L1 - LOW OUTPUT	3.5W	336	96	<a href="#">DOWNLOAD</a>
	L2 - STANDARD OUTPUT	5.25W	517	98	<a href="#">DOWNLOAD</a>
	L4 - HIGH OUTPUT	8.75W	888	101	<a href="#">DOWNLOAD</a>
<b>1" DROP</b>	L1 - LOW OUTPUT	3.5W	351	100	<a href="#">DOWNLOAD</a>
	L2 - STANDARD OUTPUT	5.25W	541	103	<a href="#">DOWNLOAD</a>
	L4 - HIGH OUTPUT	8.75W	930	106	<a href="#">DOWNLOAD</a>
<b>2" DROP</b>	L1 - LOW OUTPUT	3.5W	345	99	<a href="#">DOWNLOAD</a>
	L2 - STANDARD OUTPUT	5.25W	531	101	<a href="#">DOWNLOAD</a>
	L4 - HIGH OUTPUT	8.75W	913	104	<a href="#">DOWNLOAD</a>

## MOUNTING

### WT - TRIM

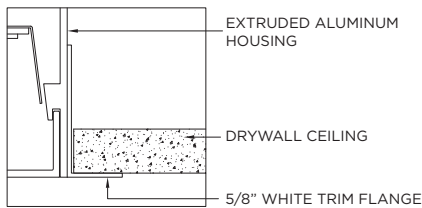

### XTR - TRIMLESS

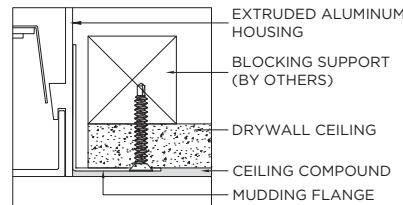

### FX - FLANGELESS

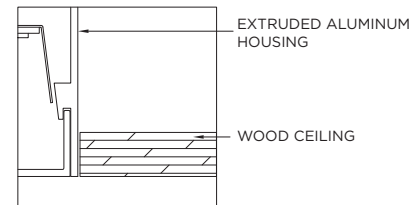

## RUN CHART (Begin measurements at start of run, in a clockwise direction)

### STRAIGHT (S-\_\_\_')

#### ORDERING EXAMPLE:

3G-4RLI-L2-30K-120-DIM-XTR-FL-S-8'



### L SHAPE (L-\_\_\_' x \_\_\_')

#### ORDERING EXAMPLE:

**A** - 3G-4RLI-L2-30K-120-DIM-XTR-FL-L-8'x6'

**B** - 3G-4RLI-L2-30K-120-DIM-XTR-FL-L-6'x8'

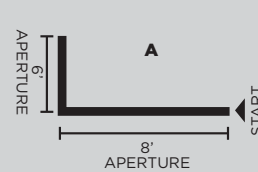

OR

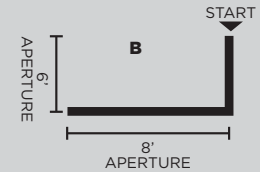

### U SHAPE (U-\_\_\_' x \_\_\_' x \_\_\_')

#### ORDERING EXAMPLE:

**A** - 3G-4RLI-L2-30K-120-DIM-XTR-FL-U-4'x8'x6'

**B** - 3G-4RLI-L2-30K-120-DIM-XTR-FL-U-6'x8'x4'

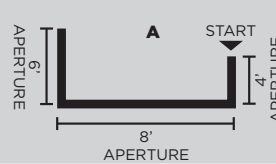

OR

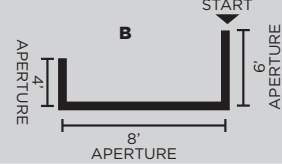

### RECTANGLE (R-\_\_\_' x \_\_\_')

#### ORDERING EXAMPLE:

3G-4RLI-L2-30K-120-DIM-XTR-FL-R-8'x6'

