

# 3G LIGHTING

## 3G-4RLI

3.5" RECESSED LINEAR  
TUNABLE WHITE & RGBW

3.5" aperture with one piece extruded aluminum housing  
Individual or continuous runs in multiple run configurations  
Suitable for drywall, grid, wood, and various architectural ceilings  
LED system with performance up to 147 lumens per watt  
Extruded acrylic lens available in flush, 1" and 2" drop lens options  
Asymmetric optics available  
1% dimming standard with several integral driver options

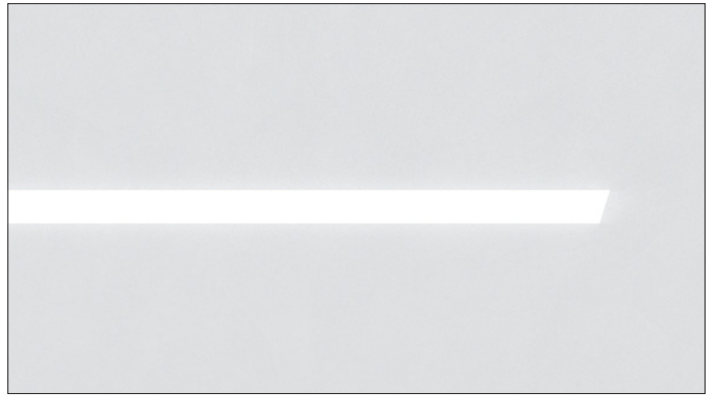

### ORDERING INFORMATION

<b>PROJECT:</b>	<input type="text"/>	<b>TYPE:</b>	<input type="text"/>
<b>CATALOG #:</b>	<input type="text"/>	<b>DATE:</b>	<input type="text"/>

CAT. NO	LED SOURCE	LUMEN OUTPUT	CRI	VOLTAGE
<b>3G-4RLI</b>	<b>TW</b> - TUNABLE WHITE (2700K-6500K)	<b>L250</b> - LOW OUTPUT (250 LM/FT) <sup>2</sup> <b>L500</b> - MEDIUM OUTPUT (500 LM/FT) <b>L750</b> - HIGH OUTPUT (750 LM/FT) <b>L1000</b> - VERY HIGH OUTPUT (1000 LM/FT) <sup>3</sup> <b>LC___</b> - CUSTOM OUTPUT (SPECIFY LM/FT)*	<b>S80</b> - 83+ CRI <b>H90</b> - 93+ CRI <sup>1</sup>	<b>UNV</b> - 120/277V
	<b>RGBW</b> - INFINITE COLOUR <sup>1</sup> (3500K WHITE)	*Specify custom lumen outputs in 50lm increments (ie: LC600, LC650, LC700) Custom output cannot exceed LC1000 Lumen outputs suitable for white LED source only		

DRIVER	FLANGE TYPE	LENS OPTION	OPTIONS
<b>DO1</b> - 0-10V (100-0.1%) <b>DALI</b> - DALI (eidoLED, 100-1%) <b>DMX</b> - DMX (eidoLED, 100-0%) <sup>1</sup> <b>DHLT</b> - LUTRON T SERIES (100-1%) (2 CHANNEL TUNABLE WHITE)	<b>WT</b> - WHITE TRIM <b>XTR</b> - TRIMLESS <b>FX</b> - FLANGELESS <b>GCX</b> - GRID CEILING (UNIVERSAL MOUNT)*	<b>FL</b> - FLUSH <b>DD1</b> - 1" DROP LENS <b>DD2</b> - 2" DROP LENS <b>DASY</b> - ASYMMETRIC OPTIC <sup>1</sup>	<b>EMB</b> - INTEGRAL EMERGENCY <sup>4</sup> BATTERY (MIN 4' SECTION) <b>EMC</b> - EMERGENCY CIRCUIT <sup>4</sup> <b>CP</b> - CHICAGO PLENUM
*Grid ceiling fixtures ship with universal mounting brackets suitable for all ceiling types. See mounting section for details			

LENGTH (FEET)
<b>S</b> - ___' (STRAIGHT RUN)* <b>L</b> - ___'X ___' (L-SHAPE) <b>U</b> - ___'X ___' X ___' (U-SHAPE) <b>R</b> - ___'X ___' (RECTANGLE/SQUARE) <b>T</b> - ___'X ___' (T-SHAPE) <b>X</b> - ___'X ___' (X-SHAPE) <b>CUS</b> - ___ (CUSTOM LAYOUT - PROVIDE DRAWING)
* Individual units available in 2', 3', 4', 5', 6' and 8' 2' not available for grid ceiling version Continuous runs available in 1' increments only

**1** RGBW LED source available with S80 (83+CRI) and DMX driver option only. Not available with asymmetric optic or EM options  
**2** L250 (250LM/FT) not available in 2' and 3' lengths. Specify LC400 for 2' and 3' fixture lengths when outputs lower than 500LM/FT are required  
**3** L1000 (1000LM/FT) not available for H90 (93+ CRI)  
**4** EMB (emergency battery) and EMC (emergency circuit) options available for tunable white LED source only. Not available with RGBW

**3GT** - Tunable White  
**3GB** - RGBW

JANUARY 6, 2021



### PERFORMANCE CHART BASED ON 4' LENGTH WITH FLUSH LENS (TUNABLE WHITE AND 83+ CRI)

COLOR TEMP	DELIVERED LUMENS (LM/FT)	SYSTEM WATTS (W/FT)	EFFICACY (LPW)
2700K	250	1.9	126
	500	3.8	121
	750	5.8	119
	1000	8.0	118
3500K	250	1.9	135
	500	3.8	130
	750	5.8	127
	1000	8.0	123
6500K	250	1.9	147
	500	3.8	145
	750	5.8	138
	1000	8.0	132

EFFICACY (LPW) ADJUSTMENT FACTOR	CRI	Multiplier
	93+	0.88

### PHOTOMETRY BASED ON 4' LENGTH (83+ CRI AND 3500K SOURCE)

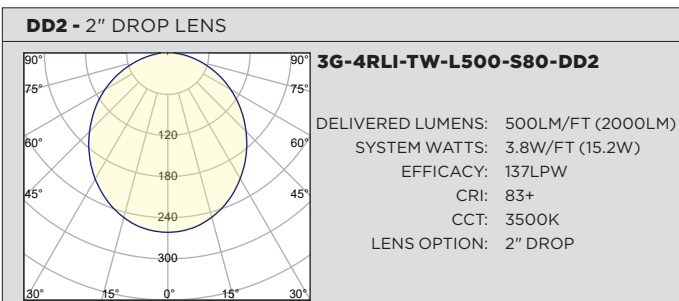
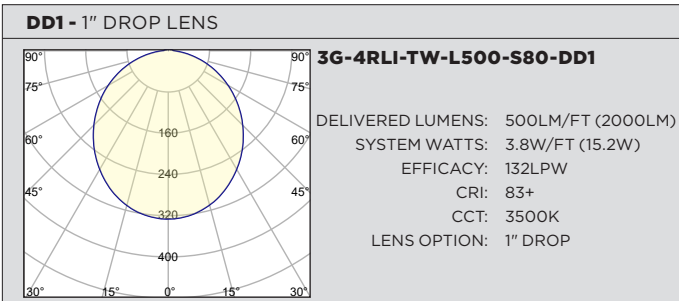
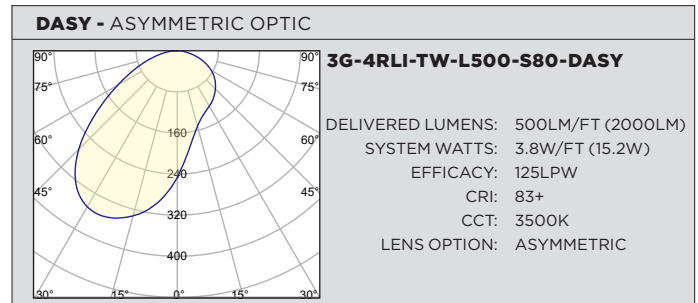
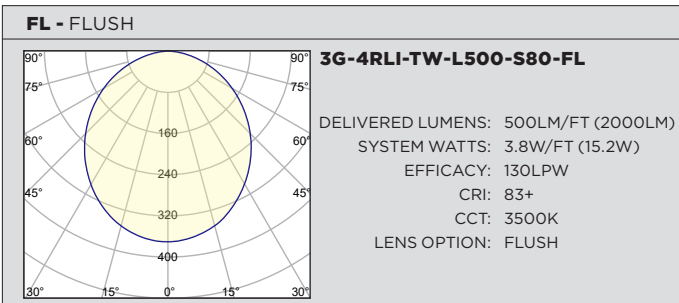

### PERFORMANCE CHART BASED ON 4' LENGTH (RGBW WITH AND 83+ CRI AND 3500K SOURCE)

COLOR TEMP	DELIVERED LUMENS (LM/FT)	SYSTEM WATTS (W/FT)	EFFICACY (LPW)
3500K	250	2.2	119
	500	4.6	113
	750	7.8	96
	1000	11.3	89
LUMINOUS INTENSITY PER LED	RGB	INTENSITY Min - Max (mcd)	
	RED	355 - 805	
	GREEN	710 - 1400	
	BLUE	140 - 355	

### PHOTOMETRY BASED ON 4' LENGTH (83+ CRI AND 3500K SOURCE)

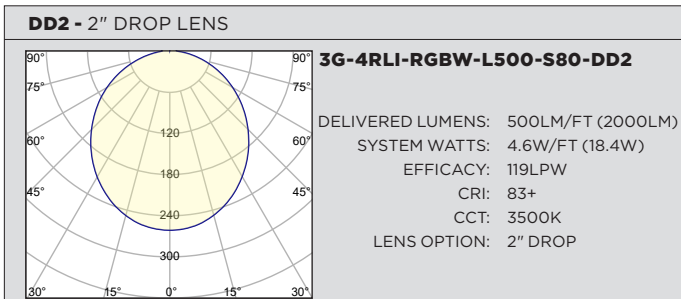
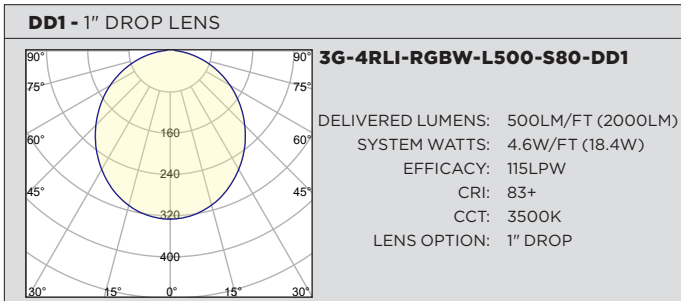
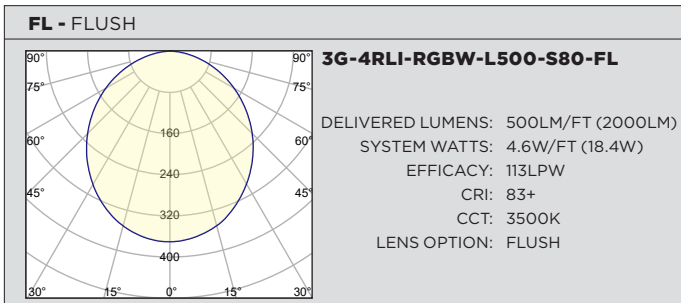

**TECHNICAL****HOUSING**

Extruded aluminum housing with 3.5" aperture  
Individual units and continuous runs available in 1' increments  
Trim flange with matte white powder coated finish and minimal 0.400" overlap  
Trimless model features a satin coat mudding flange for seamless ceiling  
24-gauge LED reflector with high reflectance white powder coated finish  
Standard polyester powder coated matte white finish

**OPTICS**

Extruded, satin acrylic lens designed for optimal performance and glare control. Up to 8' continuous  
Lens options include flush, 1" and 2" drops with illuminated end caps for all drop lenses  
High performance asymmetric optics available

**ELECTRICAL**

Luminaires are pre-wired with factory installed quick connects and branch circuit wiring  
Standard 0-10V, constant current drivers with 100-0.1% dimming range and >0.9 power factor  
eldoLED DALI driver option with 100-0.1% dimming range  
eldoLED DMX driver option with 100-0% dimming range  
Lutron T-series 2 channel tunable white driver option with 100-1% dimming range  
All drivers are integral and easily accessible through luminaire aperture  
Minimum 4' and maximum 6' length for each integral emergency battery. 10W output for 90 minutes

**LED SYSTEM FOR TUNABLE WHITE (TW)**

Proprietary LED system with color consistency <3 SDCM  
2700K-6500K CCT range  
Standard 83+CRI. Optional 93+CRI. (R9 value of 56 for 93+CRI)  
L90 >60,000 hours  
5 Year Warranty

**LED SYSTEM FOR RGBW**

Proprietary LED system with color consistency <3 SDCM  
White LED available in 35K with 83+ CRI  
L80 >72,000 hours  
Red (335-805 mcd)  
Green (710-1400 mcd)  
Blue (140-355 mcd)  
5 Year Warranty

**MOUNTING**

Housing suspended via 1/4" threaded rod or suspension cables (by others)  
Toolless installation with 3G's proprietary mounting system  
Internal, toolless joiner system (latch and hook) easily connects multiple sections together  
LED reflectors remain within each fixture section during installation with 3G's click and lock spring system  
Trim fixture designed for use in drywall, wood, and other architectural ceiling materials  
Trimless fixture designed for use in drywall, mud-in ceiling applications  
Flangeless fixture designed for use in wood ceilings  
Suitable for 4" TechZone and various grid ceiling applications (see mounting details)  
Fixture weight: +/- 3 lbs/ft

**LISTING**

ETL listed and tested to cUL standards. Suitable for dry and damp locations

**WARRANTY**

5 Year Warranty on LED and drivers  
Manufacturer 1 Year Warranty for defects in material and workmanship under normal use  
Ambient temperature at fixture should not exceed 25°C

**DRAWINGS AND DIMENSIONS**

**WT - TRIM**

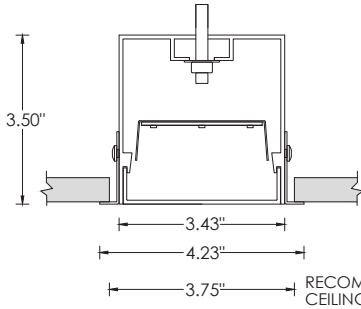

**XTR - TRIMLESS**

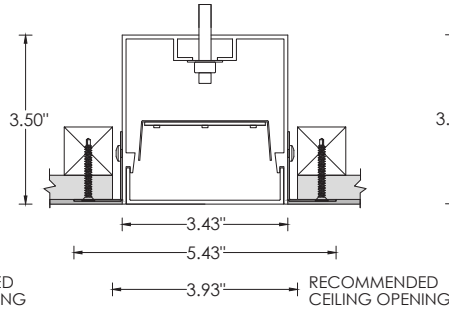

**FX - FLANGELESS**

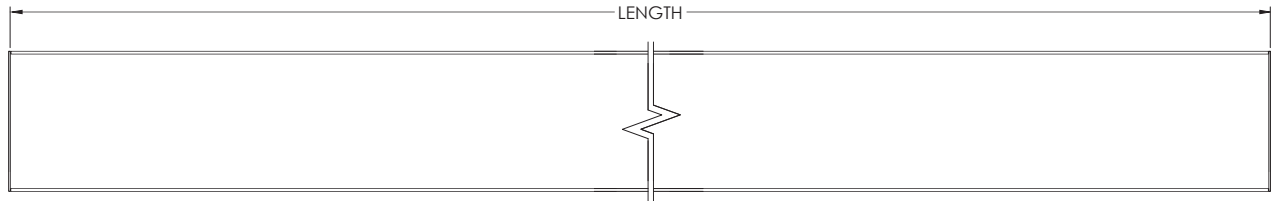
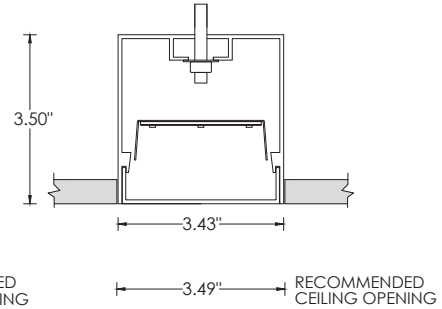

**LENS OPTION**

**FL - FLUSH**



**DD1 - 1" DROP**

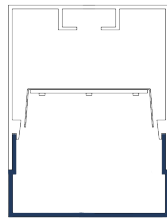

**DD2 - 2" DROP**

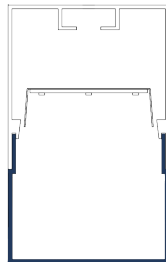

**DASY - ASYMMETRIC**

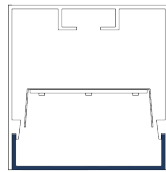

**MOUNTING DETAILS HARD CEILING**

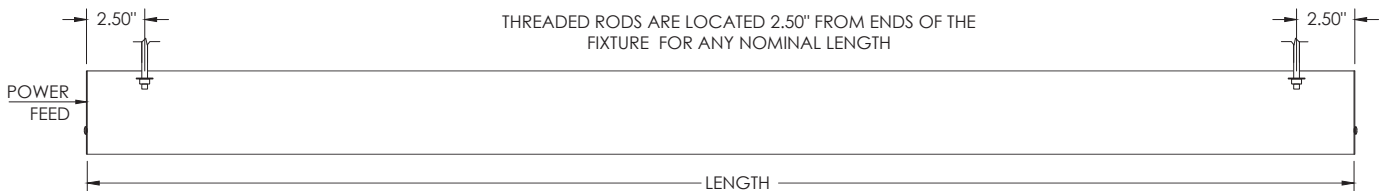

### DRAWINGS AND DIMENSIONS GRID CEILING

**9L - 9/16" LAYIN**

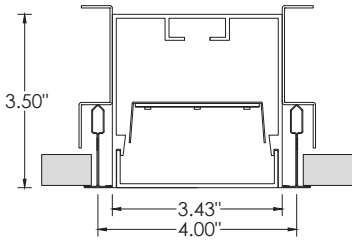

**9TG - 9/16" TEGULAR**

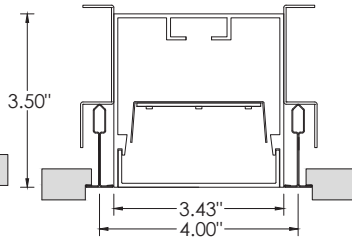

**15L - 15/16" LAYIN**

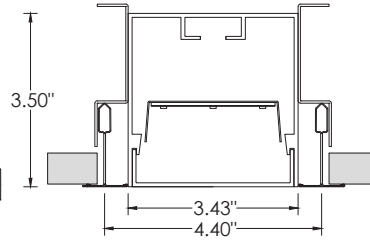

**15TG - 15/16" TEGULAR**

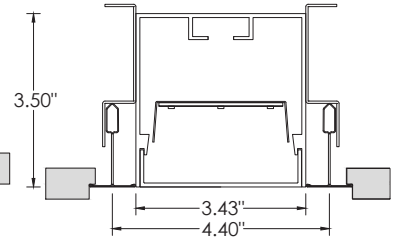

**9TP - 9/16" TEGULAR**

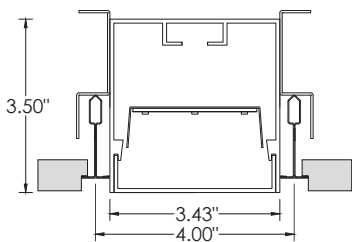

**15TP - 15/16" TEGULAR**

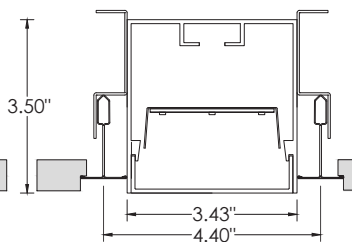

**9ST - 9/16" SLOT TEE  
TEGULAR**

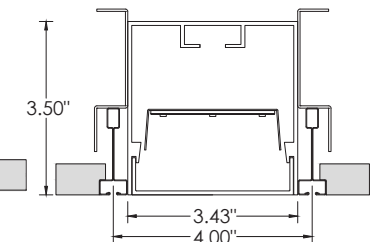

**4TZ - 4" TECH ZONE  
TEGULAR**

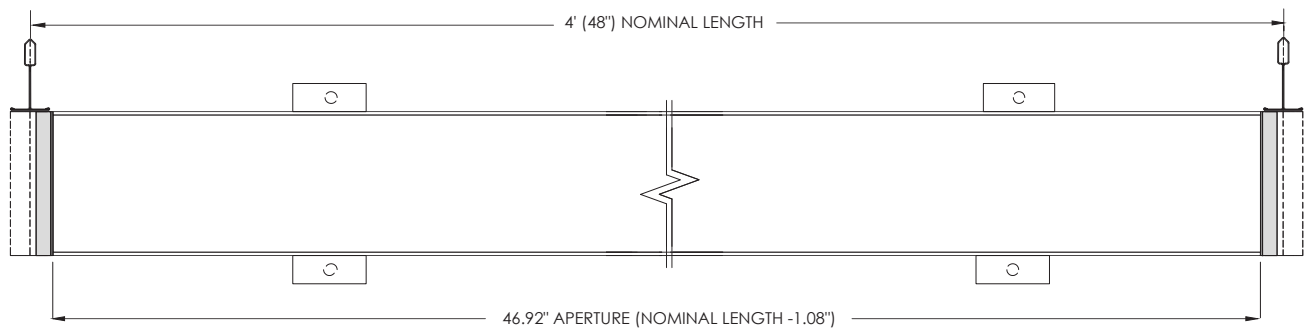
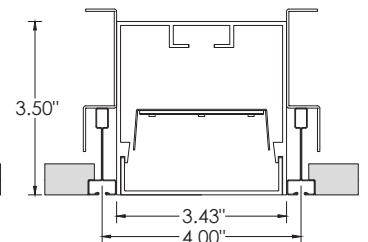

### MOUNTING DETAILS GRID CEILING

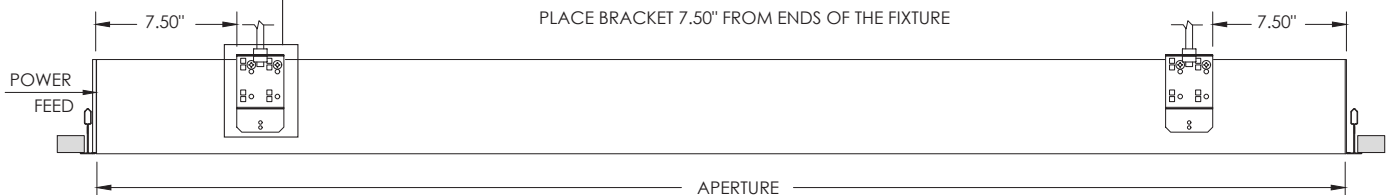
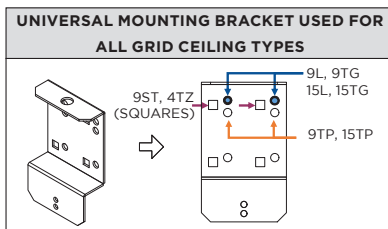

### PATTERNS

Specify pattern shape and overall dimensions as shown below  
 Patterns are connected with fully illuminated 12"x12" L, T, and X-shaped sections  
 Please consult factory for custom patterns and shapes not shown below

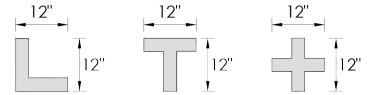

L-SHAPE	U-SHAPE	RECTANGLE/SQUARE	T-SHAPE	X-SHAPE
Provide dimensions of AxB Example: <b>L</b> - 6'x8'	Provide dimensions of AxBxC Example: <b>U</b> - 8'x10'x6'	Provide dimensions of AxB Example: <b>R</b> - 10'x8'	Provide dimensions of AxB Example: <b>T</b> - 14'x6'	Provide dimensions of AxB Example: <b>X</b> - 14'x14'

### TYPICAL SECTION MOUNTING (AVAILABLE IN 1' INCREMENTS AS STANDARD)

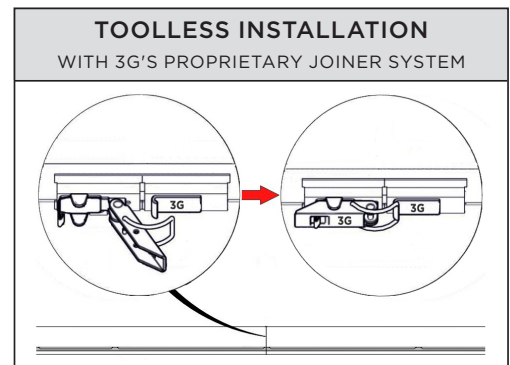
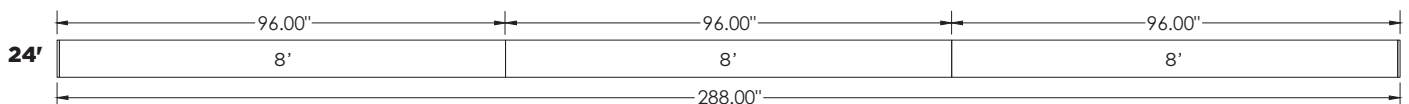
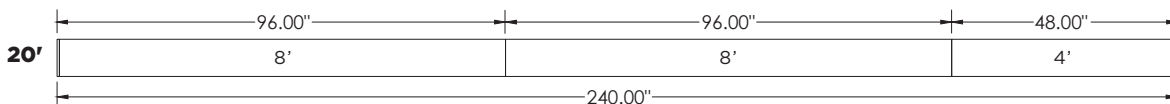
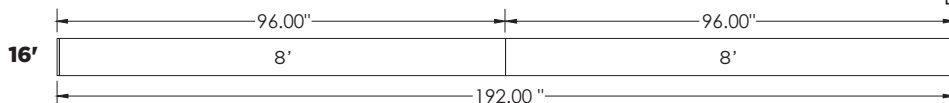
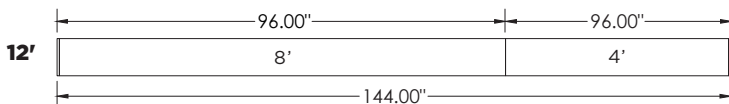
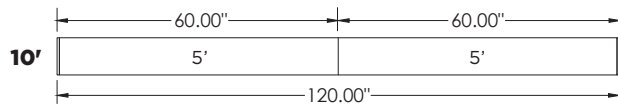

### NOTE:

Run lengths and configurations not shown are available in 1' increments as standard. Please contact 3G for 1" increments