

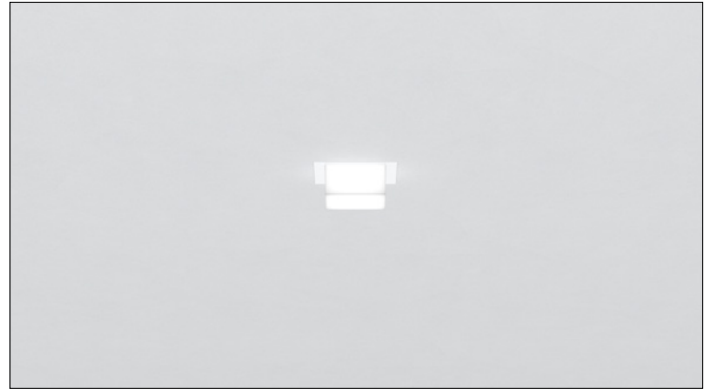

3G-RKU4

4" RECESSED KUBO



Features a white sandblasted acrylic diffuser with mitered corners
 Proprietary LED source fully saturates the hand fabricated acrylic
 Multiple drop lens options in 1" increments (flush through 3" drop)
 Drop lenses feature evenly illuminated sides with distinctive lines
 Suitable for drywall, wood, and various grid ceiling applications
 1% dimming standard with several driver options

PROJECT:		TYPE:	
CATALOG#:		DATE:	QTY:

CAT. NO	LUMEN OUTPUT	CRI	COLOR TEMP	VOLTAGE
3G-RKU4	L2 - STANDARD OUTPUT L4 - HIGH OUTPUT	S80 - 80+ CRI H90 - 90+ CRI	27K - 2700K 30K - 3000K 35K - 3500K 40K - 4000K	UNV - 120/277V 347 - 347V ¹

DRIVER	FLANGE TYPE	LENS OPTION	HOUSING TYPE
DIM - 0-10V (100-1%) DO1 - 0-10V (100-0.1%) DALI - DALI (100-1%) ² DHL2 - LUTRON HI-LUME (1% ECOSYSTEM)	WT - WHITE TRIM FLANGE XTR - TRIMLESS (MUD-IN DRYWALL)	FL - FLUSH LENS DD1 - 1" DROP LENS DD2 - 2" DROP LENS	NCF - NEW CONSTRUCTION FRAME

OPTIONS
EMC - EMERGENCY CIRCUIT

¹ 347 available in "DIM" 0-10V only (100-1%)

² DALI-2 (Type 6) provided as standard. Please consult factory for DALI (Type 8) options

BASED ON 80+ CRI AND 3500K SOURCE

LENS OPTION	DELIVERED LUMENS	SYSTEM WATTS	EFFICACY (LPW)
L2 - STANDARD OUTPUT	670	11.5	58
L4 - HIGH OUTPUT	830	16.7	49

PRELIMINARY

LUMEN OUTPUT MULTIPLIER: 27K=0.94, 30K=0.97, 35K=1.00, 40K=1.01, 90CRI=0.88

HOUSING

White sandblasted acrylic diffuser. Fabricated with mitered corners
 20 gauge cold rolled steel housing powder coated matte white
 24 gauge LED reflector powder coated matte white
 Housing Weight: 24 lbs

TRIM

Machined aluminum trim flange with powder coated finish and minimal 0.375" overlap

TRIMLESS

Mudding flange with integral blocking support installs flush with ceiling

LISTING

ETL listed and conforms to UL1598 standard. Certified to CSA22.2 NO.250.0. Rated for indoor dry or damp locations

WARRANTY

5 Year Warranty on LED and drivers
 Manufacturer 1 Year Warranty for defects in material and workmanship under normal use
 Ambient temperature at fixture should not exceed 25°C

ELECTRICAL

Standard 0-10V, constant current drivers with 100-1% dimming range and >0.9 power factor
 Standard 120/277V universal voltage drivers. Optional 347V, 0-10V drivers
 Lutron EcoSystem and eldoLED DALI options available with 100-1% dimming range
 All drivers are integral and easily accessible through luminaire aperture

LED SYSTEM

Proprietary LED system with color consistency <3 SDCM
 Available in 27K, 30K, 35K, and 40K
 Standard 80+CRI
 L90 >60,000 hours
 5 Year Warranty

MOUNTING

Suitable for various grid ceiling applications (see mounting details)
 Drywall frame kit available

TRIM HOUSING

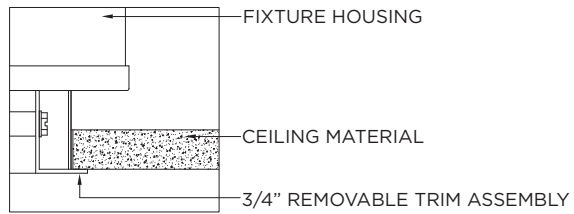
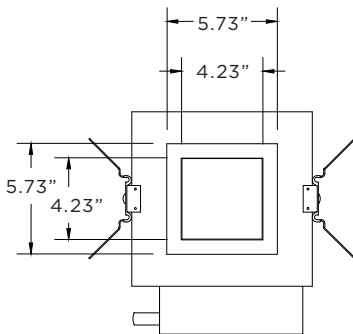
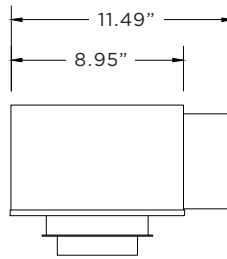
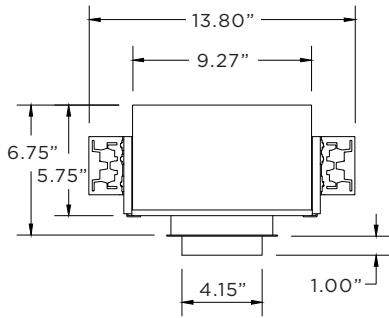

TRIMLESS HOUSING

