

3G LIGHTING

3G-4RLI

3.5" RECESSED LINIA
WALL TO CEILING

- 3.5" aperture with one piece extruded aluminum housing
- Seamless wall to ceiling illumination
- Proprietary alignment mechanism
- Suitable for drywall, wood, and grid ceiling applications
- Extruded acrylic lens available in flush, 1" and 2" drop lens options
- 1% dimming standard with several driver options

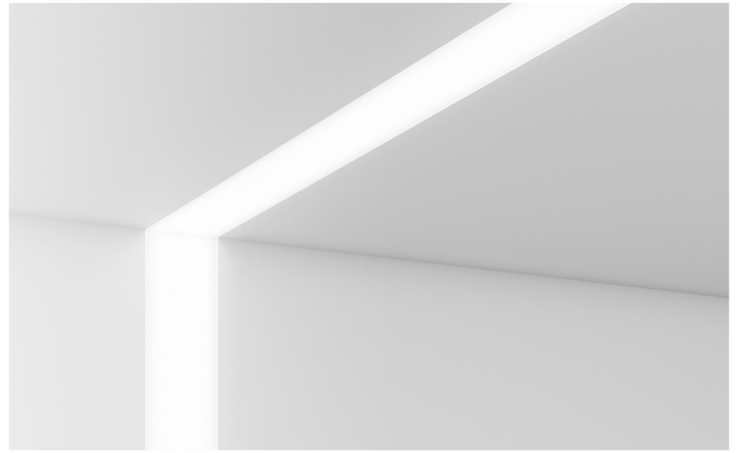

ORDERING INFORMATION

PROJECT:	<input type="text"/>	TYPE:	<input type="text"/>
CATALOG #:	<input type="text"/>	DATE:	<input type="text"/>

CAT. NO	LED SYSTEM	CRI	COLOR TEMP	VOLTAGE	DRIVER
3G-4RLI	L250 - LOW OUTPUT (250 LM/FT)	S80 - 80+CRI (STANDARD)	27K - 2700K	UNV - 120/277V 347 - 347V (0-10V ONLY)	DIM - 0-10V (STANDARD 100-1%) DHL2 - LUTRON HI-LUME LDE (100-1% ECOSYSTEM) DALI - DALI (100-1%) DO1 - 0-10V (100-0.1%)
	L500 - MEDIUM OUTPUT (500 LM/FT)		30K - 3000K		
	L750 - HIGH OUTPUT (750 LM/FT)	H90 - 90+CRI	35K - 3500K		
	L1000 - VERY HIGH OUTPUT (1000 LM/FT)	40K - 4000K			

FLANGE TYPE (WALL)	FLANGE TYPE (CEILING)	LENS OPTION	OPTIONS	LENGTH (FEET)
XTRW - TRIMLESS GXW - FLANGELESS	XTRC - TRIMLESS GXC - FLANGELESS GC1 - 9/16 LAYIN GC1S - 9/16 TEGULAR GC2 - 15/16 LAYIN GC2S - 15/16 TEGULAR GC3 - 9/16 SLOT TEE TEGULAR	FL - FLUSH DD1 - 1" DROP LENS DD2 - 2" DROP LENS	EM - INTEGRAL EMERGENCY BATTERY (4' SECTION) CP - CHICAGO PLENUM	W ___' x C ___' (WALL TO CEILING)* W ___' x C ___' x W ___' (WALL TO CEILING TO WALL) *Available in 1' increments

PERFORMANCE CHART (Based on 3500K, 4' length)

LENS OPTION	LED SYSTEM	SYSTEM WATTS (PER FT)	DELIVERED LUMENS (PER FT)	EFFICACY (LM/W)
FLUSH	L250 - LOW OUTPUT (250 LM/FT)	3.4	396	118
	L500 - MEDIUM OUTPUT (500 LM/FT)	4.9	584	120
	L750 - HIGH OUTPUT (750 LM/FT)	8.6	990	115
1" DROP	L250 - LOW OUTPUT (250 LM/FT)	3.4	411	122
	L500 - MEDIUM OUTPUT (500 LM/FT)	4.9	606	124
	L750 - HIGH OUTPUT (750 LM/FT)	8.6	1027	119
2" DROP	L250 - LOW OUTPUT (250 LM/FT)	3.4	418	124
	L500 - MEDIUM OUTPUT (500 LM/FT)	4.9	617	126
	L750 - HIGH OUTPUT (750 LM/FT)	8.6	1045	121

LUMEN OUTPUT ADJUSTMENT FACTORS: (27K=0.94) (30K=0.97) (35K=1.00) (40K=1.01)

EDITION 06/19



3G-4RLI

LIGHTING 3.5" RECESSED LINEAR - WALL TO CEILING

TECHNICAL

HOUSING

Extruded aluminum housing with 3.5" aperture
Wall to ceiling configurations available in 1' increments
Trimless model features a satin coat mudding flange
24 gauge LED reflector with high reflectance white powder coated finish
Extruded acrylic lens with a satin finish designed for optimal performance and glare control
Lens options available in flush, 1" drop and 2" drop
Standard polyester powder coated matte white finish

ELECTRICAL

Standard 0-10V, 100-1% dimming and 0.9 power factor
Standard 120/277V universal voltage drivers. Optional 347V 0-10V driver
Lutron EcoSystem and eldoLED Dali options available with 100-1% dimming
All driver are integral and easily accessible through the aperture
Integral Emergency Battery: 90 minutes

LED SYSTEM

Proprietary LED system
Color consistency < 3 SDCM
Standard (80+CRI). Optional (90+CRI)
Available in 27K, 30K, 35K, and 40K
Average rated life of > 50,000 hours
5-year warranty

MOUNTING

Proprietary alignment mechanism for seamless wall to ceiling illumination
Suitable for drywall and wood ceilings (see mounting details)
Suitable for various architectural ceilings (see mounting details)

LISTING

ETL listed and tested to UL standards. Suitable for dry and damp locations

WARRANTY

5 Year warranty on LED and drivers
Manufacturer 1-year warranty for defects in material and workmanship under normal use
Ambient temperature at fixture should not exceed 25°C

DRAWINGS AND DIMENSIONS

XTRW - TRIMLESS

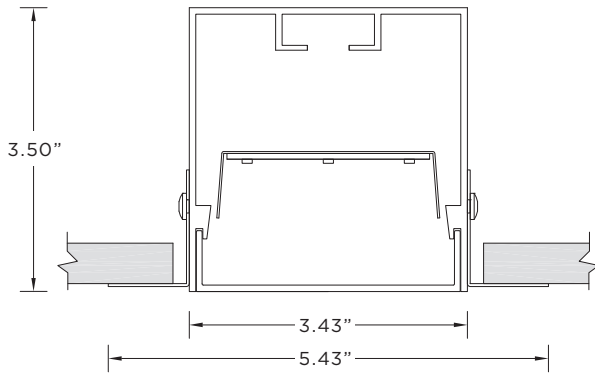

GXW - FLANGELESS

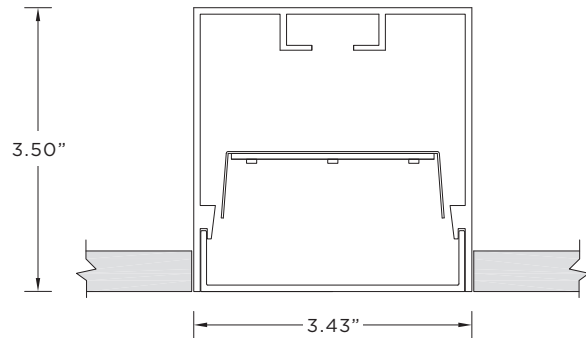

LENS OPTION

FL - FLUSH LENS

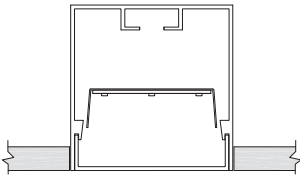

DD1 - 1" DROP LENS

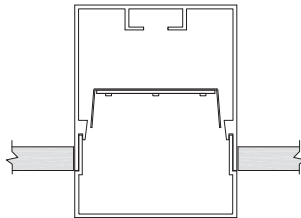

DD2 - 2" DROP LENS

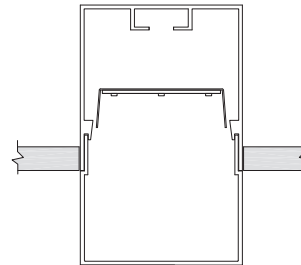

MOUNTING

CEILING-TRIMLESS

WALL-TRIMLESS

CEILING-FLANGELESS

CEILING-FLANGELESS

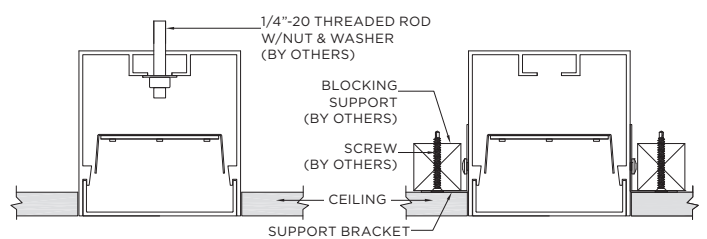
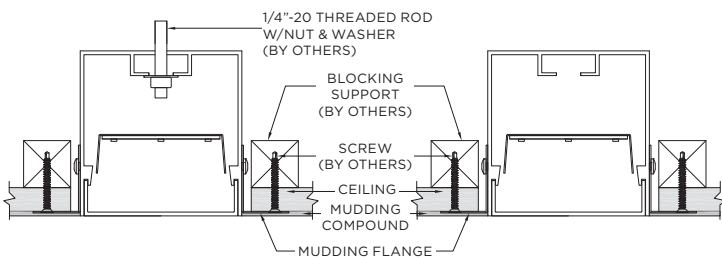

CEILING CUT-OUT
3.93" x (LENGTH + 0.5")

CEILING CUT-OUT
3.93" x (LENGTH + 0.5")

CEILING CUT-OUT
3.49" x (LENGTH + 0.125")

CEILING CUT-OUT
3.49" x (LENGTH + 0.125")